

# FENIX4 / FENIX+

Monitoring system



FIRE SAFETY

## FENIX



## Commissioning instruction

07/11/2023



## FENIX

### Contents

General .....	2
Products .....	3
1. Installation .....	3
2. Connection .....	4
3. Commissioning .....	6
Functions .....	9
Management and service .....	10

### General

The FENIX4 master control unit and FENIX+ slave unit contain electronic components that may be damaged in the event of improper use. When connecting dampers, smoke detectors and other connections, the unit must be powered down!

The cover to access the terminal blocks is removed by unscrewing the cover on the lower part of the control unit. The connection terminals for 230 V AC are opened by inserting a screwdriver with a suitable width into the notch above the connector and then bend the screwdriver slightly upwards.



**Products**

**System structure**

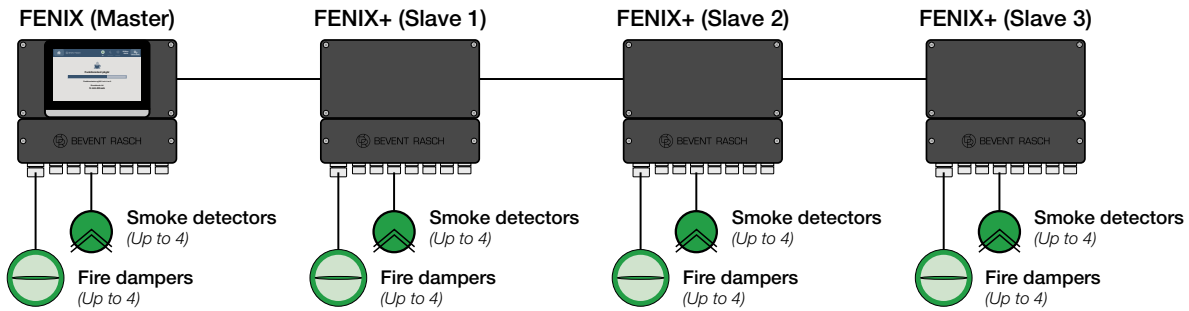

**FENIX4 master**

FENIX4 is the device with the interactive touch display. FENIX4 supports between 1-4 dampers and smoke detector circuits, which are automatically detected during commissioning. FENIX4 is used either independently for monitoring 1-4 dampers and smoke detector circuits or together with slave units FENIX+ for up to 16 dampers and smoke detector circuits.



**FENIX+ slave unit**

FENIX+ works as an additional module for the possibility to connect an additional 1-4 dampers and smoke detector circuits to the system. The FENIX+ slave unit is automatically identified by FENIX4 and connected dampers and smoke detector circuits are automatically shown as usual on the display of FENIX4. FENIX+ is addressed easily with a physical knob, see the connection instructions for more information.



**FENIX 0-10 V module**

When using regulating fire dampers, regulation can be performed in two different ways, either via a local 0-10 V signal out at the damper or via master communication (Modbus TCP or BACnet IP). If local control is desired with 0-10 V, the FENIX 0-10 V module is used to separate the local control signal, from, e.g. a room sensor, and the 10 V signal from FENIX that takes over during a functional test to check that the dampers can open.



**1. Installation**



Install FENIX4 and FENIX+ with the requisite fasteners. A wall mount frame is fitted on the units at the factory and should be used to maintain the IP65 enclosure class.

The FENIX 0-10 V module is mounted on a wall or cable ladder. Power supply cables and end position indication from the damper motor are connected directly to the damper module. This in turn, is connected to FENIX4 master or FENIX+ slave unit.





## 2. Connection cont.

Connection terminals	Function	Description
4+5, 11+12, 18+19, 25+26	Connection of smoke detector circuits	Each smoke detector circuit should have a 2.2 kOhm's resistance mounted at the end of the circuit, see the wiring diagram. The terminating resistance of 2.2 kOhm is connected to the last detector in each circuit. If a central fire alarm and/or no smoke detectors are used, a resistance of 2.2 kOhm should not be installed on these terminals. Max 24 V DC 90 mA.
6-10, 13-17, 20-24, 27-31	Connection of fire damper	For standard ON/OFF dampers, the input is not used for 10 V, this is done only for regulating dampers, see wiring diagrams. The damper output on G and G0 is 24 V DC, max 10 VA per output. <b>Note! Only 1 fire damper per output!</b>
Inputs	Function	Description
32+33	External function test/resetting External alarm	In the event of a short circuit, the controller performs a functional test and may reset the external incoming alarm, provided that terminals 34+35 do not have an open circuit. These terminals cannot be jumpered for automatic resetting. Instead, see options under settings.
34+35	External incoming alarm	In the event of an open circuit between terminals, External incoming alarm is activated, jumpered on delivery and if External incoming alarm is not used.
36+37	Night mode	In the event of short circuiting of the terminals, the panel enters Night mode whereby all dampers close without the controller generating alarms. Used, for example, during intermittent operation. Night mode can also be a good safety measure for preventing the spread of combustion gases when the ventilation is switched off, duct-mounted smoke detectors do not have the same opportunity to detect smoke when no air is transported in the system.
Outputs	Function	Description
38+39+40	A-alarm	Programable potential-free changeover contacts: Triggered detector (not changeable), Damper error, Network error (loss of communication to FENIX+), Detector error, External alarm, Internal battery needs to be replaced, Service alarm detector. Will also changeover at power outage. In normal operation, terminals 38+40 have contact. Drawn in de-energised/alarm mode. Max 24 V AC/DC, 3 A.
41+42+43	B-alarm	Programable potential-free changeover contacts: Triggered detector, Damper error, Network error (loss of communication to FENIX+), Detector error, External alarm, Internal battery needs to be replaced, Service alarm detector. Will also changeover at power outage. In normal operation, terminals 41+43 have contact. Drawn in de-energised/alarm mode. Max 24 V AC/DC, 3 A.
44+45	External stop of fan/unit	Programable potential-free changeover contacts: Triggered detector, Damper error, Network error (loss of communication to FENIX+), Detector error, External alarm, Automatic functional testing of fire dampers. Will also changeover at power outage. In normal operation, terminals 44+45 have contact. Drawn in de-energised/alarm mode. Max 24 V AC/DC, 3 A.
46+47+48	Bus contact, communication between FENIX and FENIX+	Communication cable between FENIX and FENIX+ is connected here.
	Network connection	Cable connection RJ45, 10Base-T/100Base-TX auto-negotiation Cable length Max. 100 m Cabling Min. Cat 5
	Addressing slave units	Addressing knob for slave unit (FENIX+ only). Connected slave units shall be addressed in the order: 1, 2, 3. Turn the knob to change the address.
	Indication of communication between master unit FENIX and slave unit FENIX+	Green LED on                      Voltage on, everything OK Red LED on                        Battery problems FENIX4 Orange flashing 1 time/sec    No contact between FENIX+ and FENIX4

- Measure the voltage with a multimeter use a well-known brand.
- Check cables using an Ohmmeter with all devices disconnected.
- Never use a megohmmeter!
- The connection and disconnection of all cables are made with FENIX4 master and FENIX+ slave unit de-energized.



## 3. Commissioning

1. Make sure that connected slave units are addressed in the order 1, 2, 3 according to the addressing knob at the far right of the FENIX+ slave unit as shown below. If no FENIX+ slave unit is used, you can ignore this point.

### FENIX+ slavenhet

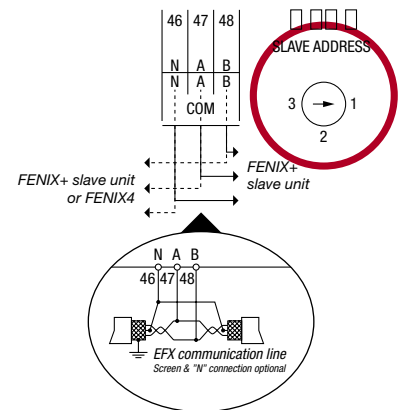
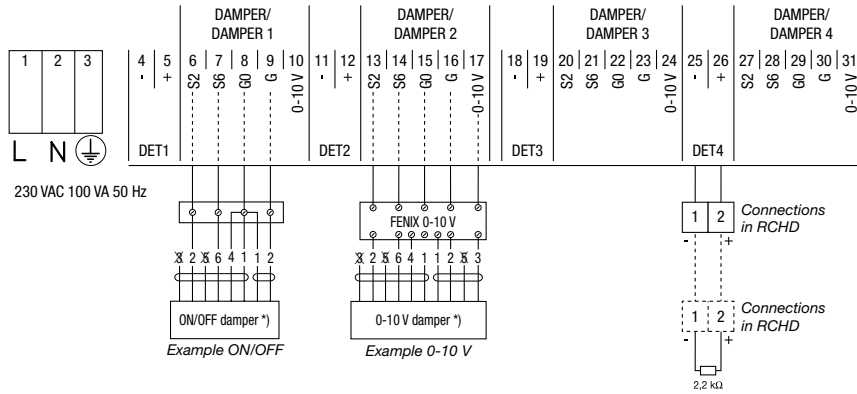

2. Power the units with 230 V AC.
3. Press START on the display and follow the commissioning instructions below.

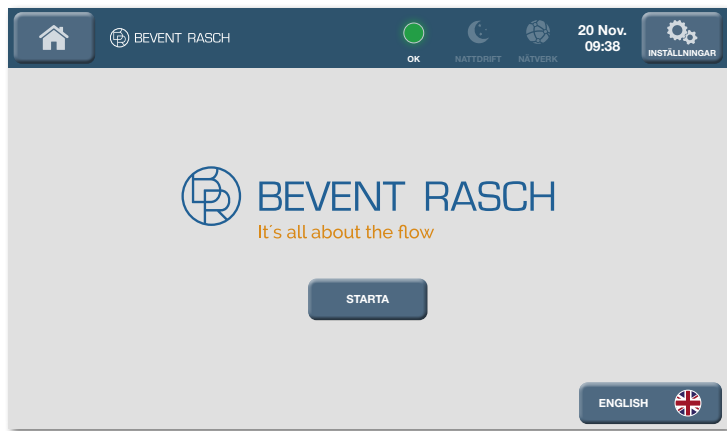

The start page when powered up.



Example system with 1 FENIX+ slave unit.

Make sure that the number of FENIX+ slave units found matches your installation.

If the number of units is not correct, use the troubleshooting guide on the display.

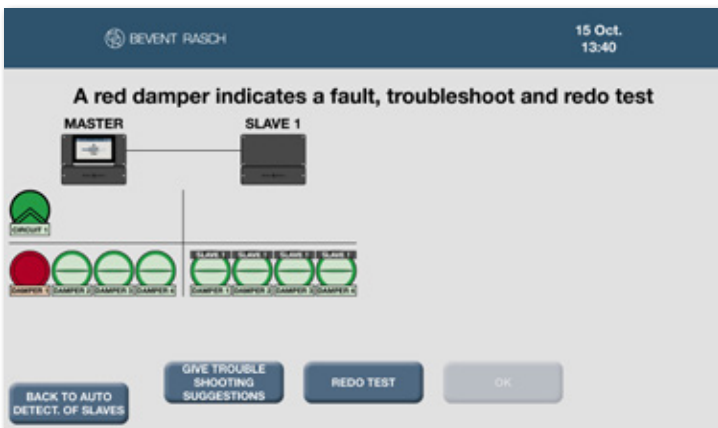

Example system with 1 smoke detector circuit and 8 fire dampers with a faulty or broken damper.

If a fire damper is connected incorrectly or does not work, a red icon will appear.

For safety reasons, a faulty system cannot be started. Use the troubleshooting guide on the display to correct the fault before commissioning.

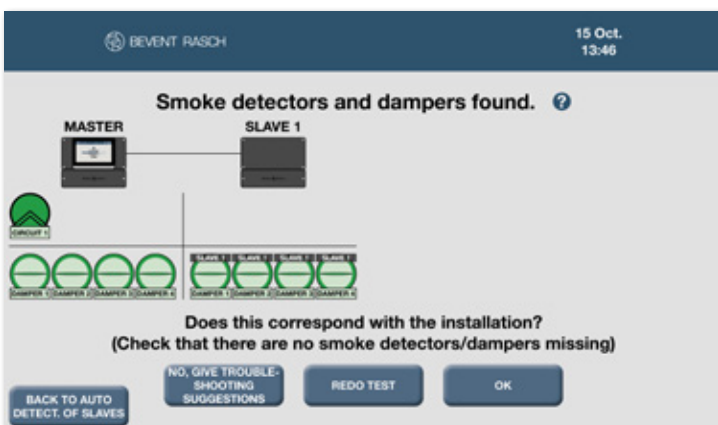

Example system with 1 smoke detector circuit and 8 fire dampers.

Check that the number of fire dampers and smoke detector circuits found match the installation.

Use the troubleshooting guide on the display if your dampers or smoke detector circuits are not displayed.

NB: The icons also show whether the dampers are of ON/OFF type or regulating 0-10 V.



## Symbol descriptions

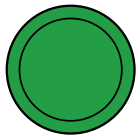

Closed damper

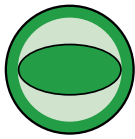

Damper in middle position

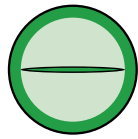

Open damper



**"DAMPER 1"**

Indicates which damper on the unit FENIX4 / FENIX+

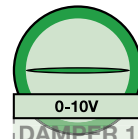

**"0-10 V"**

Indicates whether the damper is regulating: 0-10 V = regulating No box = On/Off



**"SLAVE 1"**

**"0-10 V"**

Indicates which slave unit the damper belongs to.

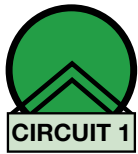

**"CIRCUIT 1"**

Green = All OK

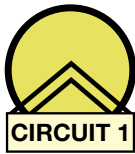

**"CIRCUIT 1"**

Yellow = Service

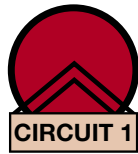

**"CIRCUIT 1"**

Red = Error / Alarm

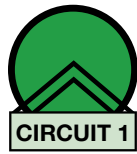

**"CIRCUIT 1"**

Indicates which detector circuit on the unit FENIX4 / FENIX+



**"SLAVE 1"**

**"CIRCUIT 1"**

Indicates which slave unit the detector circuit belongs to.

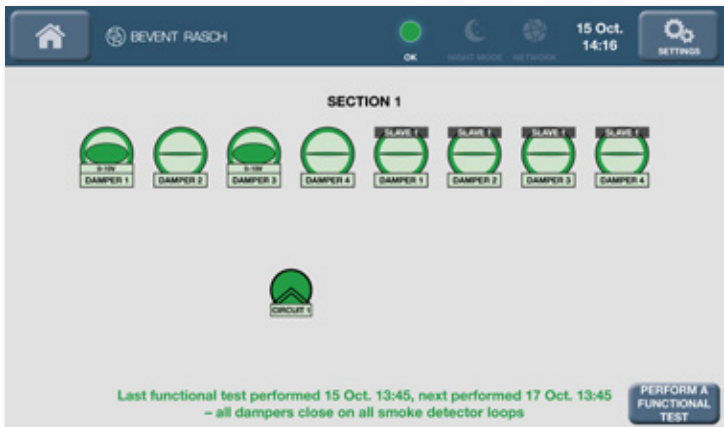

Example system with 1 smoke detector circuit and 8 fire dampers after correct commissioning.

After an approved functional test has been carried out, FENIX is part of the fire protection.





## Function description

### Functions and settings via the display

#### **Date and Time**

The date and time are set from the factory, but can be easily changed on-site if necessary. The unit is equipped with automatic summer and winter time adjustment.

#### **Language**

Easily choose between Swedish and English.

#### **Zone dampers and smoke detector circuits**

The dampers and smoke detector circuits can easily be divided into up to four zones. The zones then serve as their own fire compartments and the smoke detector circuits can close one or more zones. This is a function that can be used, for example, for tenant adaptations where the entire system should not shut down on each local smoke detector circuit. Default setting: all smoke detectors and fire dampers belong to zone 1.

#### **Time of functional testing**

Easily set the interval when functional testing of the fire dampers is performed and when during the day to do it.

Selectable ranges:

- 1 time every 24 hours
- 1 time every 48 hours  
(recommended and default setting on delivery)
- 1 time per week
- 1 time per month
- 1 time every 6 months

#### **Perform functional testing**

If necessary, you can easily perform a functional test via the display on FENIX4. Can also be performed by shorting terminals 32 and 33.

#### **Device information and communication settings**

Simply set the desired communication settings for Modbus TCP or BACnet IP via the display.

IP address is assigned automatically via Dynamic Host Configuration Protocol (DHCP). If a fixed IP address is desired, this can be configured via the settings in the touch display.

#### **Delay External stop**

If desired, functional testing of fire dampers can be delayed by 5 minutes. Relay "EXT. STOP" between terminals 44 and 45 then breaks directly for internal functional testing, the functional test of the dampers is performed first after a 5 minute delay, which then allows the electric heating coils to cool down. Default setting: no delay.

#### **Automatic reset of External incoming alarm**

Normally an External incoming alarm (34 + 35) needs to be acknowledged on the unit via the display or terminal block 32 + 33 (default setting), this function permits External incoming alarms to be acknowledged automatically when a possible external alarm stops. Default setting: no automatic reset.

#### **System reset**

The system is easily reset to the default settings when necessary.

#### **Alarm history**

Shows the 30 latest alarms divided on two pages. The list is of the type FIFO, the latest alarm is always shown on row 1 och new alarms will be shown when generated.

#### **Name damper and smoke detectors**

On these pages dampers and smoke detectors can be named and their location can be noted. The pages will only show the physical dampers and smoke detectors that are connected.

NOTE! The information written here will only be shown on these pages, not on the regular overview.

#### **Programable alarm outputs (Alarm Settings)**

On this page you can select which alarm conditions that will affect the separate alarm outputs.

The former alarm outputs "Sumalarm" and "Detector service alarm" are now called "A-alarm" and "B-alarm".

NOTE! The selections on this page will only affect the alarm outputs, dampers will still close if an alarm is triggered.



## **Automatic functions integrated in FENIX**

### **Dynamic troubleshooting diagrams**

Instead of the traditional troubleshooting documents that previously accompanied older controllers, FENIX shows exactly what fault occurred and proposed actions directly on the display, such as if a damper does not make contact with the limit switch for the closed position:

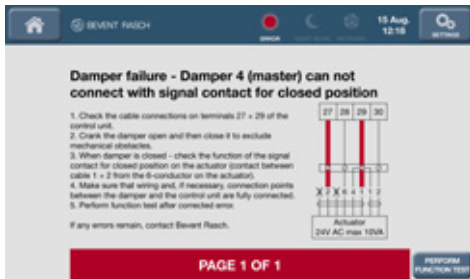

The unit then shows exactly what damper fault has been identified, the possible slave unit FENIX+ that the damper belongs to and which connection terminals and cables should be checked and troubleshot. This function facilitates any service and troubleshooting in the event of a fault during the lifespan of the property. The same pedagogical approach applies to smoke detector circuits, external alarms and other functions that trigger something in the controller.

Dynamic trouble shooting diagrams and associated action texts play an important role in the simplicity of FENIX.

### **Automatic functional testing**

All connected fire dampers are automatically functionally tested. In order to ensure that regulating dampers work at all damper angles, check the limit switches for both the open and closed positions for all connected dampers.

### **Automatic shutdown of the entire system in the event of alarms in two different zones**

As a safety measure, all connected fire dampers are closed if two smoke detectors from different zones alarm at the same time. This is because it can then be assumed that the fire has spread between the fire compartments and that the entire system should be closed.



## Management and service

The FENIX system is designed to facilitate management and service by presenting troubleshooting suggestions and measures for each specific service issue. This means that you do not have to keep any troubleshooting manuals and other documentation.

The unit will alert when the internal battery needs to be replaced. This can also be done in connection with service or an obligatory ventilation control (OVK).

### Instructions for replacing the battery

1. Power down the unit, no 230 V AC must be connected when replacing the battery.
2. Remove the cover by loosening the screws as shown below.

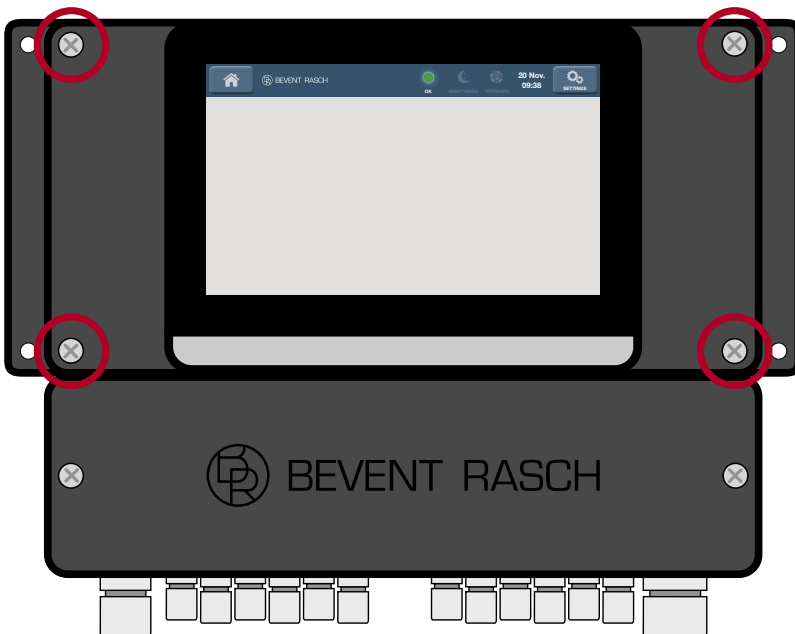

3. Replace the CR2032 battery on the right side of the PCB.

Replace the battery within 10 seconds to prevent the unit from losing its settings. If the unit is left without a battery connected for more than 10 seconds, any settings must be made again.

4. Refit the front by screwing on the cover again.
5. The unit automatically restarts with retained settings.

