

# FENIX2

Monitoring system for  
up to 2 fire dampers



FIRE SAFETY



# FENIX

07/11/2023



## FENIX



### Quick facts

- For monitoring up to 2 fire dampers
- Also manages 0-10 V (regulating) fire dampers
- Dynamic troubleshooting screens on the interactive touch display with action proposals for each potential fault
- Automatic detection of connected dampers and smoke detector circuits
- Selectable language Swedish/English
- Modbus TCP / BACnet IP

### System description

FENIX is the next generation system for monitoring fire dampers. FENIX2 can manage 1–2 dampers, both ON/OFF 24 V dampers and regulating 0-10 V dampers. The modern display constantly displays an intuitive and straightforward screen that is very easy to understand, a very important function to increase the simplicity and man-

agement of such an important function as fire monitoring. FENIX2 is fully backward compatible with our older generations of controllers, which means that existing cabling and dampers can be used for ROT projects. The carefully prepared design of FENIX2 results in many small values for the user. Diagonal placement of the cables glands for cables, flashing icons to facilitate for those with colour blindness, and small descriptive help texts on each page of the display are just a few examples of how refined and adapted FENIX2 is for maximised user-friendliness.

### FENIX2

FENIX2 is a control unit with an interactive touch display. FENIX2 supports between 1–2 dampers and smoke detector circuits, which are automatically detected during commissioning. FENIX2 is a simpler and stripped-down variant of FENIX4 and thus cannot handle any FENIX+ slave units.

The connection instructions are also provided on the lid of the FENIX2 to assist installation.



**FENIX 0-10 V module**

When using regulating fire dampers, regulation can be performed in two different ways, either via a local 0-10 V signal out at the damper or via master communication (Modbus TCP or BACnet IP). If local control is desired with 0-10 V, the FENIX 0-10 V module is used to separate the local control signal, from, e.g. a room sensor, and the 10 V signal from FENIX that takes over during a functional test to check that the dampers can open.

**Function description**

**Functions and settings via the display**

**Date and Time**

The date and time are set from the factory, but can be easily changed on-site if necessary. The unit is equipped with automatic summer and winter time adjustment.

**Language**

Easily choose between Swedish and English.

**Time of functional testing**

Easily set the interval when functional testing of the fire dampers is performed and when during the day to do it. Selectable ranges:

- 1 time every 24 hours
- 1 time every 48 hours  
(recommended and default setting on delivery)
- 1 time per week
- 1 time per month
- 1 time every 6 months

**Perform functional testing**

If necessary, you can easily perform a functional test via the display on FENIX2. Can also be performed by shorting terminals 32 and 33.

**Device information and communication settings**

Simply set the desired communication settings for Modbus TCP or BACnet IP via the display.

IP address is assigned automatically via Dynamic Host Configuration Protocol (DHCP). If a fixed IP address is desired, this can be configured via the settings in the touch display.

**Delay External stop**

If desired, functional testing of fire dampers can be delayed by 5 minutes. Relay “EXT. STOP” between terminals 44 and 45 then breaks directly for internal functional testing, the functional test of the dampers is performed first after a 5 minute delay, which then allows the electric heating coils to cool down.

Default setting: no delay.

**Automatic reset of External incoming alarm**

Normally an External incoming alarm (34 + 35) needs to be acknowledged on the unit via the display or terminal block 32 + 33 (default setting), this function permits External incoming alarms to be acknowledged automatically when a possible external alarm stops. Default setting: no automatic reset.

**System reset**

The system is easily reset to the default settings when necessary.

**Automatic functions integrated in FENIX**

**Dynamic troubleshooting diagrams**

Instead of the traditional troubleshooting documents that previously accompanied older controllers, FENIX shows exactly what fault occurred and proposed actions directly on the display, such as if a damper does not make contact with the limit switch for the closed position:

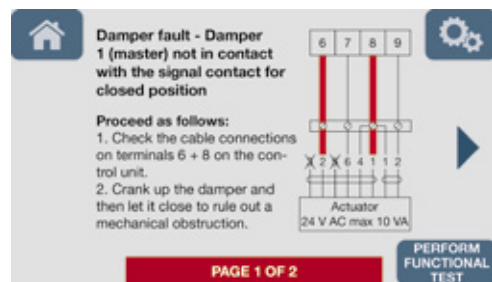

The unit then shows exactly what damper fault has been identified and which connection terminals and cables should be checked and troubleshot. This function facilitates any service and troubleshooting in the event of a fault during the lifespan of the property. The same pedagogical approach applies to smoke detector circuits, external alarms and other functions that trigger something in the controller.

Dynamic trouble shooting diagrams and associated action texts play an important role in the simplicity of FENIX.

**Automatic functional testing**

All connected fire dampers are automatically functionally tested. In order to ensure that regulating dampers work at all damper angles, check the limit switches for both the open and closed positions for all connected dampers.



## Symbol descriptions

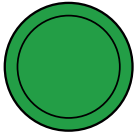

Closed damper



Damper in middle position

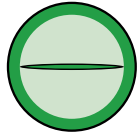

Open damper



**"DAMPER 1"**  
Indicates which damper on the unit  
FENIX4 / FENIX+

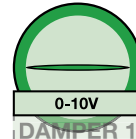

**"0-10 V"**  
Indicates whether the damper is regulating:  
0-10 V = regulating  
No box = On/Off

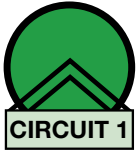

Green  
= All OK

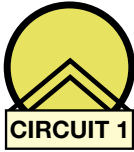

Yellow  
= Service

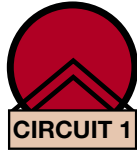

Red  
= Error / Alarm

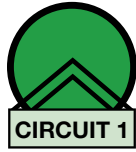

**"CIRCUIT 1"**  
Indicates which detector circuit on the unit  
FENIX4 / FENIX+

## Specification

Control unit **FENIX2**

Accessories:

- RCKD/-RD** - smoke detectors
- FENIX 0-10 V module** - for local regulation of 0-10 V dampers
- RCHD** - overtemperature detector



## Dimensions, weight and technical data

### FENIX2

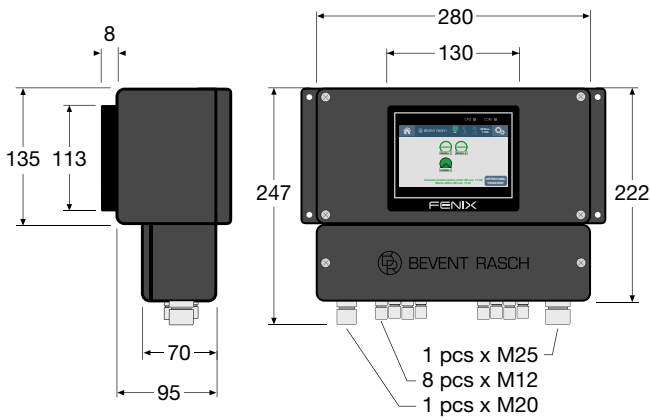

### Technical data FENIX2

Supply voltage:	230 V AC +10% -15%, 50 Hz
Power rating:	230 V ~ 100VA T40
Enclosure class:	IP 65
Ambient temp.:	0° – +40°C
Output relays:	Potential free, 24 V, 3A AC/DC @ resistive load
Max. load per damper output:	10 VA, 24V DC
Max. detectors per output:	2 pcs.
Internal fuse:	250V 1.6A

### FENIX 0-10 V module

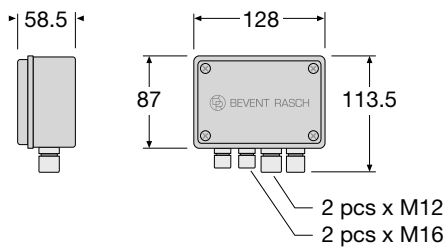

### Technical data FENIX 0-10 V module

Enclosure class:	IP 56
Ambient temp.:	0° – +50°C



# Monitoring system FENIX2

## Inputs and outputs (For descriptions of terminals, see next page)

### FENIX2

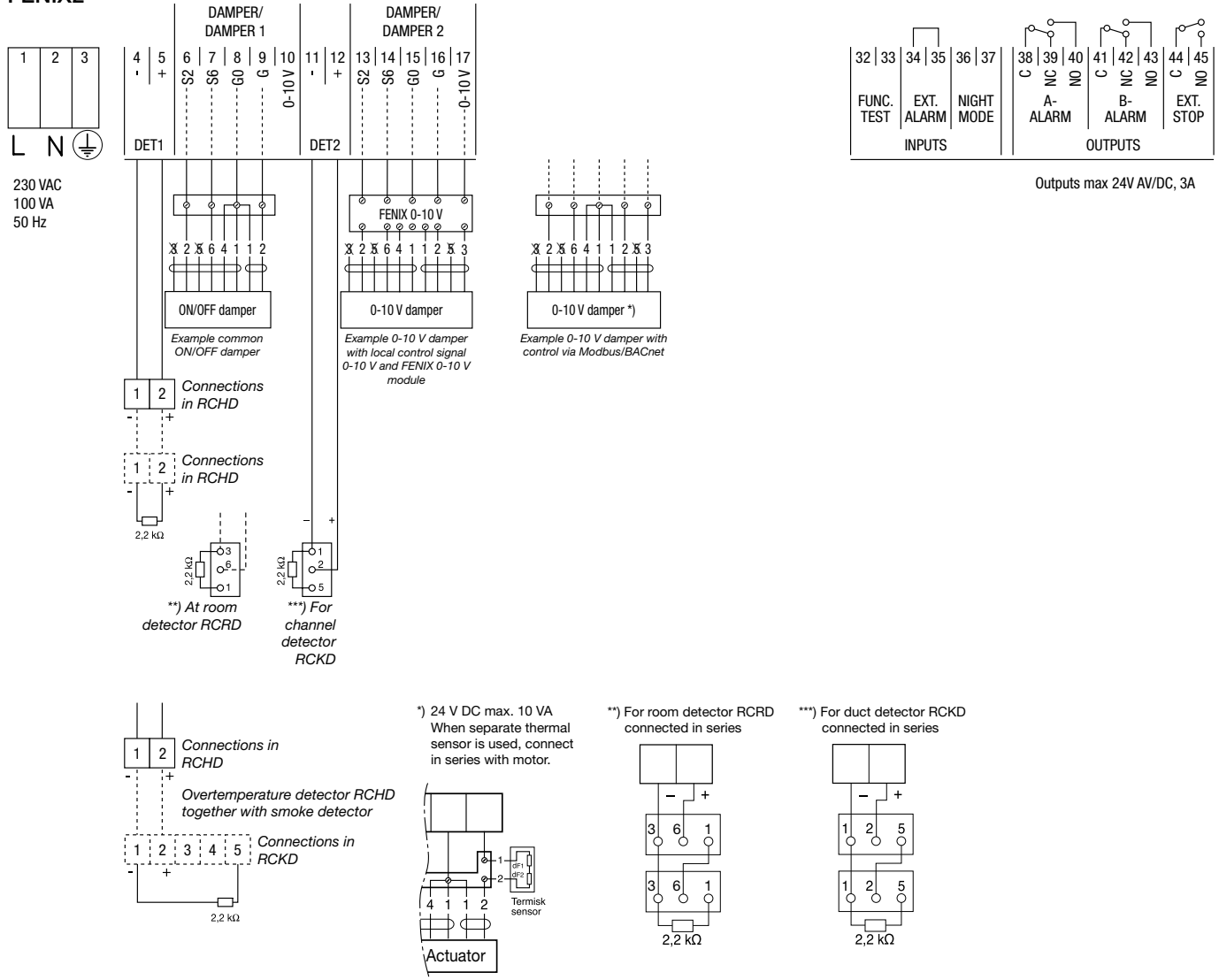

## Cable recommendations

ON/OFF dampers, e.g. BSKC6  
= EKKR/ELQRB/EQQRB 4x1 mm<sup>2</sup>

Regulating damper 0-10 V, e.g. BSKC6R  
= EKKR/ELQRB/EQQRB 5x1 mm<sup>2</sup> (7x1 mm<sup>2</sup>)

For local 0-10 V control from, for example room sensors, the FENIX 0-10 V module is used.

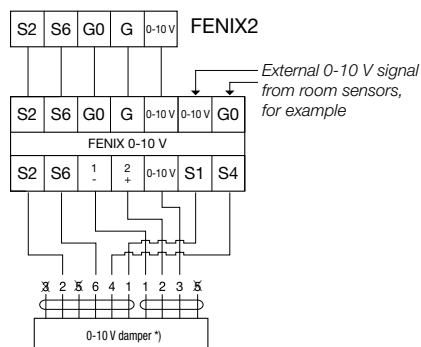



## Inputs and outputs continued

Connection terminals	Function	Description
4+5, 11+12	Connection of smoke detector circuits	Each smoke detector circuit should have a 2.2 kOhm's resistance mounted at the end of the circuit, see the wiring diagram. The terminating resistance of 2.2 kOhm is connected to the last detector in each circuit. If a central fire alarm and/or no smoke detectors are used, a resistance of 2.2 kOhm should not be installed on these terminals. Max 24 V DC 90 mA.
6-10, 13-17	Connection of fire damper	For standard ON/OFF dampers, the input is not used for 10 V, this is done only for regulating dampers, see wiring diagrams. The damper output on G and G0 is 24 V DC, max 10 VA per output. <b>Note! Only 1 fire damper per output!</b>
Inputs	Function	Description
32+33	External function test/resetting External alarm	In the event of a short circuit, the controller performs a functional test and may reset the external incoming alarm, provided that terminals 34+35 do not have an open circuit. These terminals cannot be jumpered for automatic resetting. Instead, see options under settings.
34+35	External incoming alarm	In the event of an open circuit between terminals, External incoming alarm is activated, jumpered on delivery and if External incoming alarm is not used.
36+37	Night mode	In the event of short circuiting of the terminals, the panel enters Night mode whereby all dampers close without the controller generating alarms. Used, for example, during intermittent operation. Night mode can also be a good safety measure for preventing the spread of combustion gases when the ventilation is switched off, duct-mounted smoke detectors do not have the same opportunity to detect smoke when no air is transported in the system.
Outputs	Function	Description
38+39+40	Main alarm (A-alarm on circuit board)	Potential-free changeover contact that switches for: • Detector failure • Damper failure • Tripped detector • External incoming alarm • Power outage • System failure • Communication failure with slave units • Internal battery needs to be replaced In normal operation, terminals 38+40 have contact. Drawn in de-energised/alarm mode. Max 24 V AC/DC, 3 A
41+42+43	Service alarm detector circuits (B-alarm on circuit board)	Potential-free changeover contact that switches for soiled detector. In normal operation, terminals 41+43 have contact. Drawn in de-energised/alarm mode. Max 24 V AC/DC, 3 A
44+45	External stop of fan/unit	Breaking potential-free contact that breaks for: • Functional testing of fire dampers • Main alarm In normal operation, terminals 44+45 have contact. Drawn in de-energised/alarm mode. Max 24 V AC/DC, 3 A
	Network connection	Cable connection RJ45, 10Base-T/100Base-TX auto-negotiation Cable length Max. 100 m Cabling Min. Cat 5

- Measure the voltage with a multimeter use a well-known brand.
- Check cables using an Ohmmeter with all devices disconnected.
- Never use a megohmmeter!
- All cable connections and disconnections are done with the FENIX2 powered down.